

Table of Contents

WARNINGS	2
IMPORTANT SAFETY INSTRUCTIONS	8
COOKING UTENSILS	8
APPLIANCE DESCRIPTION	10
MICROWAVE OVEN INSTALLATION	11
CONTROL PANEL	12
OPERATION	13
General	13
Setting the Clock	13
Kitchen Timer	13
Microwave Cooking	14
Speed Cooking	14
Defrosting by Weight	15
Defrosting by Time	15
Multi-Stage Cooking	15
Auto Menu	16
Child Lock	18
Foods	18
CLEANING AND MAINTENANCE	19
SPECIFICATIONS	21
TROUBLESHOOTING	21
DISPOSAL	22

WARNINGS

- ❖ **IMPORTANT SAFETY INSTRUCTIONS**
READ CAREFULLY AND KEEP FOR FUTURE REFERENCE
- ❖ This appliance is intended to be used in household and similar applications such as:
 - staff kitchen areas in shops, offices and other working environments;
 - farm houses;
 - by clients in hotels, motels and other residential type environments;
 - bed and breakfast type environments.
- ❖ If the supply cord is damaged, it must be replaced by the manufacturer, its service agent or similarly qualified persons in order to avoid a hazard.
- ❖ **WARNING:** If the door or door seals are damaged, the oven must not be operated until it has been repaired by a competent person.
- ❖ **WARNING:** It is hazardous for anyone other than a competent person to carry out any service or repair operation that involves the removal of a cover which gives protection against exposure to microwave energy.

- ❖ **WARNING:** Liquids and other foods must not be heated in sealed containers since they are liable to explode.
- ❖ Keep a minimum free space 30 cm above the top surface of the oven.
- ❖ Only use utensils that are suitable for use in microwave ovens.
- ❖ When heating food in plastic or paper containers, keep an eye on the oven due to the possibility of ignition.
- ❖ The microwave oven is intended for heating food and beverages. Drying of food or clothing and heating of warming pads, slippers, sponges, damp cloth and similar may lead to risk of injury, ignition or fire.
- ❖ If smoke is emitted, switch off or unplug the appliance and keep the door closed in order to stifle any flames.
- ❖ Microwave heating of beverages can result in delayed eruptive boiling; therefore care must be taken when handling the container.
- ❖ The contents of feeding bottles and baby food jars shall be stirred or shaken and the temperature checked before consumption, in order to avoid burns;

- ❖ Eggs in their shell and whole hard-boiled eggs should not be heated in microwave ovens since they may explode, even after microwave heating has ended.
- ❖ For the details for cleaning door seals, cavities and adjacent parts, please see section “Cleaning and Maintenance” on pages EN-19 & 20.
- ❖ The oven should be cleaned regularly and any food deposits removed.
- ❖ Failure to maintain the oven in a clean condition could lead to deterioration of the surface that could adversely affect the life of the appliance and possibly result in a hazardous situation.
- ❖ The microwave oven is intended to be used freestanding.
- ❖ The appliance must not be placed in a cabinet.
- ❖ This appliance is Group 2 Class B equipment.
Group 2 equipment: group 2 contains all ISM RF equipment in which radio-frequency energy in the frequency range 9 kHz to 400 GHz is intentionally generated

and used or only used locally, in the form of electromagnetic radiation, inductive and/or capacitive coupling, for the treatment of material, for inspection/analysis purposes, or for transfer of electromagnetic energy.

Class B equipment is equipment suitable for use in locations in residential environments and in establishments directly connected to a low voltage power supply network which supplies buildings used for domestic purposes.

- ❖ The rear surface of appliance shall be placed against a wall.
- ❖ **WARNING:** The appliance and its accessible parts become hot during use. Care should be taken to avoid touching heating elements. Children less than 8 years of age shall be kept away unless continuously supervised.
- ❖ **WARNING:** Accessible parts may become hot during use. Young children should be kept away.
- ❖ This appliance is not intended to be operated by means of an external timer or separate remote-control system.

- ❖ This appliance can be used by children ages from 8 years and above and persons with reduced physical, sensory or mental capabilities or lack of experience and knowledge if they have been given supervision or instruction concerning use of the appliance in a safe way and understand the hazards involved. Children shall not play with the appliance. Cleaning and user maintenance shall not be made by children unless they are older than 8 and supervised.
- ❖ Keep the appliance and its cord out of reach of children less than 8 years.
- ❖  The surfaces are liable to get hot during use.
- ❖ During use the appliance becomes hot. Care should be taken to avoid touching heating elements inside the oven.
- ❖ Do not use harsh abrasive cleaners or sharp metal scrapers to clean the oven door glass since they can scratch the surface which may result in shattering of the glass.
- ❖ A steam cleaner is not to be used.
- ❖ The appliance shall not be cleaned with a steam cleaner.

- ❖ The temperature of accessible surfaces may be high when the appliance is operating.
- ❖ The plug must be remained easily accessible after installation of the appliance.
- ❖ After each cooking cycle, the cooling fan will continue to run for a while to ensure quick cooling and safe operation of the oven.
- ❖ The door should preferably be closed in all cooking modes.
- ❖ Do not line the oven's cavity with aluminium foil for easier cleaning: The oven may overheat and the enamel coating of the cavity may be damaged.
- ❖ Metallic containers for food and beverages are not allowed during microwave cooking. The appliance must not be installed behind a decorative door in order to avoid overheating.

IMPORTANT SAFETY INSTRUCTIONS

- When you will not use the microwave oven for a long period of time, please disconnect it from the supply mains, to do this you must remove the plug from the supply outlet.
- The microwave oven cannot be operated with the door open due to the safety interlocks built into the door mechanism which switch off the cooking functions when the door is opened. Operating the microwave oven with the door open could result in harmful exposure to microwave energy. It is important not to tamper with the door mechanism.
- Do not let water or any other liquid enter the oven through the ventilation slots.
- Do not place any object between the oven front face and the door or allow soil or cleaner residue to accumulate on sealing surfaces.
- Avoid using straight-sided containers with narrow necks.
- Stir any liquid before placing the container back into the microwave oven half way through the heating time.
- After heating, always allow standing time, stir or shake the contents and carefully check the temperatures before consumption.

COOKING UTENSILS

Utensils should be checked to ensure that they are suitable for use in the microwave oven.

Materials you can use in microwave oven

Utensils	Remarks
Browning dish	Follow manufacturer's instructions. The bottom of browning dish must be at least 5 mm above the turntable. Incorrect usage may cause the turntable to break.
Dinnerware	Microwave-safe only. Follow manufacturer's instructions. Do not use cracked or chipped dishes.
Glass jars	Always remove lid. Use only to heat food until it's warm. Most glass jars are not heat resistant and may break.
Glassware	Heat-resistant oven glassware only. Make sure there is no metallic trim. Do not use cracked or chipped dishes.
Oven cooking bags	Follow manufacturer's instructions. Do not close with metal tie. Make slits to allow steam to escape.

Paper plates and cups	Use for short-term cooking/warming only. Do not leave oven unattended while cooking.
Paper towels	Use to cover food for reheating and absorbing fat. Use with supervision for a short-term cooking only.
Parchment paper	Use as a cover to prevent splattering or a wrap for steaming.
Plastic	Microwave-safe only. Follow the manufacturer's instructions. Should be labelled "Microwave Safe". Some plastic containers soften, as the food inside gets hot. "Boiling bags" and tightly closed plastic bags should be slit, pierced or vented as directed by package.
Plastic wrap	Microwave-safe only. Use to cover food during cooking to retain moisture. Do not allow plastic wrap to touch food.
Thermometers	Microwave-safe only (meat and candy thermometers).
Wax paper	Use as a cover to prevent splattering and retain moisture.

Materials to be avoided in microwave oven

Utensils	Remarks
Aluminium tray	May cause arcing. Transfer food into microwave-safe dish.
Food carton with metal handle	May cause arcing. Transfer food into microwave-safe dish.
Metal or metal-trimmed utensils	Metal shields the food from microwave energy. Metal trim may cause arcing.
Metal twist ties	May cause arcing and could cause a fire in the oven.
Paper bags	May cause a fire in the oven.
Plastic foam	Plastic foam may melt or contaminate the liquid inside when exposed to high temperature.
Wood	Wood will dry out when used in the microwave oven and may split or crack.

NOTES:

- Care should be taken when removing utensils or the glass turntable, as they may become hot during cooking.
- Only use a thermometer that is designed for use in the microwave oven.
- Ensure the turntable is in place when you operate the oven.

APPLIANCE DESCRIPTION

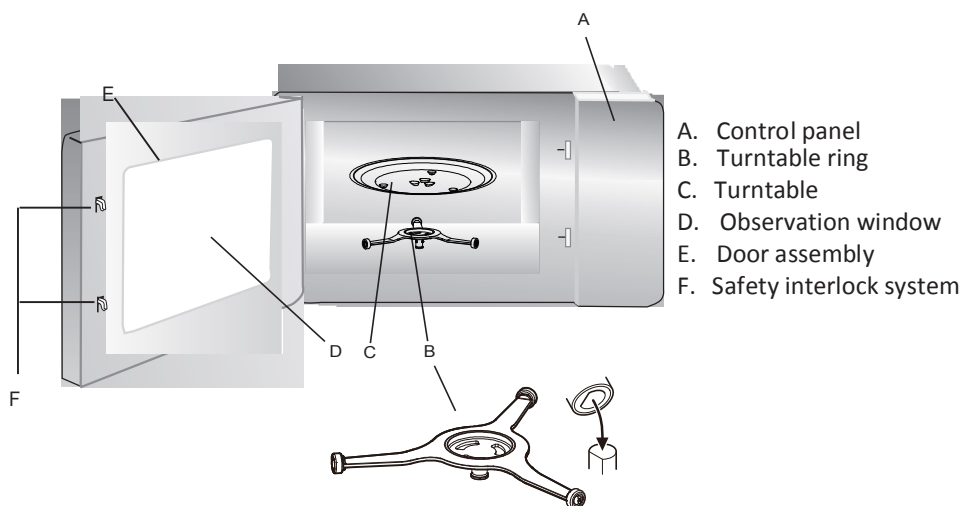

Turntable

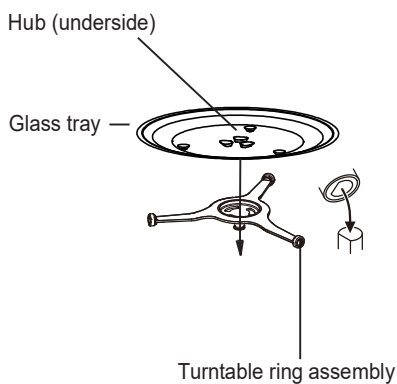

- Never place the glass tray upside down. The glass tray should never be restricted.
- Both glass tray and turntable ring must always be used during cooking.
- All food and containers of food are always placed on the glass tray for cooking.
- If glass tray or turntable ring cracks or breaks, contact your nearest authorised service centre.

MICROWAVE OVEN INSTALLATION

Preparation

Remove all packing material and accessories. Examine the oven for any damage such as dents or broken door. Do not install the microwave oven if it is damaged.

Cabinet: Remove any protective film found on the microwave oven cabinet surface.

Do not remove the light brown Mica cover that is attached to the inside of the oven cavity to protect the magnetron.

Position

- Select a level surface that provides enough open space for the intake and/or outlet vents.

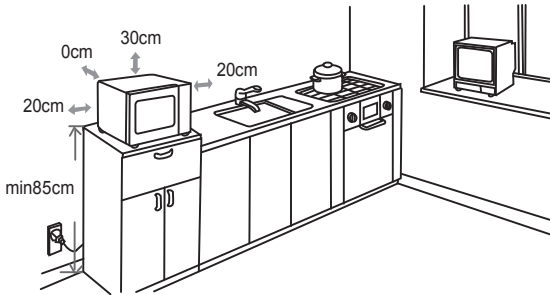

- The microwave oven must be placed on a surface with height more than 85 cm above the floor.
- A minimum clearance of 20 cm is required on both sides of the oven.
- The minimum height of free space above the top surface on the oven is 30 cm.
- Do not remove the feet from the bottom of the oven.
- Blocking the intake and/or outlet openings can damage the oven.
- Place the oven as far away from radios and TV as possible.
- Operation of microwave oven may cause interference to your radio or TV reception.
- Plug your oven into a standard grounded outlet. Be sure the voltage and the frequency are the same as the voltage and the frequency on the rating label.
- **WARNING:** Do not install the oven over a range cooktop or other heat-producing appliance. If installed near or over a heat source, the oven could be damaged and the warranty would be void.

CONTROL PANEL

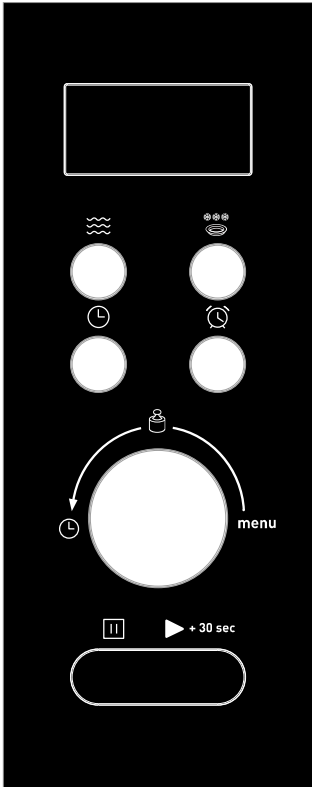

Microwave cooking

Press this button to set microwave power level.



Defrosting by weight or time

Press this button to defrost food by weight or time.



Clock

Press this button to set the clock.



Kitchen timer

Press this button to set the kitchen timer.



/ menu (dial)

Rotate this dial to select auto menus or enter time or weight.



Stop/Clear

- Press this button to cancel setting or reset the oven before setting a cooking programme.
- Press once to temporarily stop cooking or press twice to cancel cooking completely.
- It is also used for setting child lock.



+ 30 sec Start/+30Sec./Confirm



- Press this button to start a cooking programme or set speed cooking programme.
- Press to confirm the setting.

OPERATION





When the oven is plugged in, the display will show "0:00" and a beep will be heard.

EN

General



1. Press  once to temporarily stop cooking and you can resume cooking by pressing  + 30 sec, or press  twice to cancel the cooking programme.
2. After the cooking time has elapsed, the oven will beep five times and return to the standby state.

Setting the Clock

1. Press  to set the clock in 24-hour cycle.
 - The hour digits will flash.
2. Turn  to adjust the hour digits, the input hour should be a 24-hour time value.
3. Press , the minute digits will flash.
4. Turn  to adjust the minute digits.
5. Press  to confirm the setting. ":" will flash on the display.

NOTE: During clock setting, if you press , the oven will return to the previous state.

Kitchen Timer

1. Press . The display will show "00:00".
2. Turn  to enter the correct time. The maximum cooking time is 95 minutes.
3. Press  + 30 sec to confirm setting.
4. When the time has elapsed, the oven will sound five times.







Microwave Cooking

The maximum cooking time is 95 minutes.

You can select a power level by pressing .



Press 	Display	Cooking Power
once	P100	100%
twice	P80	80%
3 times	P50	50%
4 times	P30	30%
5 times	P10	10%

Example: Choose 80% power for cooking 20 minutes.

1. Press  once.
 - “P100” will flash on the display.
2. Press  again or turn  to choose 80% microwave power.
 - “P80” will flash on the display.
3. Press  + 30 sec to confirm.
4. Turn  to set the cooking time until “20:00” is shown on the display.
5. Press  + 30 sec to start cooking.



NOTE: You can check the cooking power during cooking by pressing .

Speed Cooking

- In standby state, press  + 30 sec to cook with 100% power level for 30 seconds. Each time you press the button, the cooking time will be increased by 30 seconds. The maximum cooking time is 95 minutes.
- In standby state, turn  anticlockwise to choose cooking time then press  + 30 sec to cook with 100% microwave power.



Defrosting by Weight

You can use the oven to defrost food based on the weight selected. The defrosting time and power level are automatically set once the weight is entered. The frozen food weight ranges from 100g to 2000g.

1. Press  once.
 - "d01" will be shown on the display.
2. Turn  to select the desired food weight.
3. Press  **+ 30 sec** to start defrosting.

Defrosting by Time

You can also choose to defrost food by entering the defrost time yourself.

1. Press  twice.
 - "d02" will be shown on the display.
2. Turn  to select the desired defrosting time. The maximum defrosting time is 95 minutes.
3. Press  **+ 30 sec** to start defrosting.

NOTE: The defrosting power is P30 and this cannot be changed.

Multi-Stage Cooking







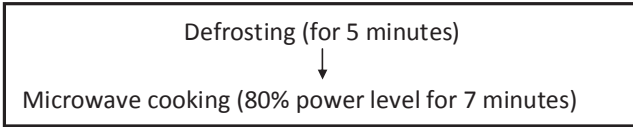

Your oven can be programmed for up to 2 automatic cooking sequences.

NOTE:

- Auto menu cooking cannot be selected in the multi-stage cooking programme.
- Defrosting can only be set in the first stage.

Suppose you want to set the following cooking programme:







1. Press  twice.
• “d02” will be shown on the display.
2. Turn  to select the defrosting time until “5:00” is shown on the display.
3. Press  once.
4. Repeatedly press  or turn  to select the microwave power level until “P80” is displayed.
5. Press  + **30 sec** to confirm.
6. Turn  to select the cooking time until “7:00” displays.
7. Press  + **30 sec** to start cooking.

NOTE: After one cooking stage is finished, a beep sound will be heard, indicating the next cooking stage has begun.

Auto Menu

For the food in the following table, it is not necessary to programme the cooking power and time. Take the following steps:





1. In standby state, turn  clockwise to select the desired menu from the table below.
2. Press  + **30 sec** to confirm.
3. Turn  to select the food weight.
4. Press  + **30 sec** to start cooking.

Menu	Weight	Display	Power
A1 Reheat	200 g	200 g	100%
	400 g	400 g	
A2 Meat	250 g	250 g	100%
	350 g	350 g	
	450 g	450 g	
A3 Vegetable	200 g	200 g	100%
	300 g	300 g	
	400 g	400 g	
A4 Pasta	50 (with 450 ml cold water)	50	80%
	100 (with 800 ml cold water)	100	
A5 Potato	1 (about 230 g)	1	100%
	2 (about 460 g)	2	
	3 (about 690 g)	3	
A6 Fish	250 g	250 g	80%
	350 g	350 g	
	450 g	450 g	
A7 Beverage	1 cup (about 120 ml)	1	100%
	2 cups (about 240 ml)	2	
	3 cups (about 360 ml)	3	
A8 Popcorn	50 g	50 g	100%
	100 g	100 g	

NOTE: Peel the potatoes and cut them into 2 or 3 equal pieces before cooking.

Child Lock

The child lock prevents the oven from being operated unintentionally or by unsupervised children.

- To set the child lock, press and hold  until a beep sounds and the lock indicator light () will be shown on the display. In the lock state, all buttons are disabled.
- To cancel the child lock, press and hold  until a beep sounds and the lock indicator light () will disappear from the display.

NOTE: This function is only available when the oven is not in operation.

Foods

Forbidden foods

If you choose a cooking method using microwaves, you should never:

- Attempt to fry food - it is impossible to control the temperature of the oil and other fats- fire-risk.
- Attempt to cook or warm up eggs in their shells, hard-boiled eggs with or without their shells or snails - they may explode.
- Attempt to cook food in an intact shell (e.g. chestnuts) or hard skin (tomatoes, potatoes, sausages) - always make a slit.

Food temperatures

The action of microwaves is such that only the food is heated. The container may, therefore, remain cold or cool while the food that it contains is burning hot.

To avoid any risk of burning, always stir before serving and check the temperature carefully before serving - especially to children.

Shake feeding bottles well and try a few drops on the back of your wrist to check the temperature.

Preparing food for cooking

Before warming feeding bottles and small pots, remove teats and covers.

Remember to cover the food in order to:

- avoid any splashing of the oven cavity,
- retain sufficient moisture for cooking.

Heating liquids

When heating liquids, a sudden overflow may occur when you take the container to remove it from the appliance. In fact, when the temperature reaches boiling point, steam tends to remain trapped in the liquid until it is disturbed.

To avoid this superheating effect and the consequent risk of scalding, always place a plastic spoon in the liquid to be heated.

A container can easily be tested for microwave “transparency”:

Place the empty container on the turntable together with a glass of water and run the oven for one minute at maximum power.

After one minute:

- if the container is cold, it is “transparent” and can be used for microwave cooking,
- if the container is warm or hot it is absorbent and must not be used for microwave cooking.

CLEANING AND MAINTENANCE

Before any cleaning or maintenance operation, disconnect the microwave oven from the mains supply and allow it to cool to room temperature.

General Advice

Frequent cleaning prevents the formation of smoke and bad odours during cooking and also sparking in the oven cavity and around the door seal.

Do not let food deposits or grease accumulate inside the oven cavity or on the door seal.

Make sure that the waveguide cover is kept clean at all times. Should food deposits or grease be allowed to accumulate on the cover, sparking will occur and may damage your oven invalidating the warranty.

Oven Door

Remove any food deposits and grease between the door seal and oven cavity using a damp cloth, it is important to keep this area clean at all times.

Interior Walls

Remove any grease splashes from the oven cavity walls using a damp cloth dipped in water and a mild detergent. Rinse and dry with a soft cloth.

The door seal and oven cavity have to be particularly well cleaned to ensure the door will close properly and to avoid sparking between the oven cavity and door assembly.

Do not use abrasive products such as scouring pads which will damage the surfaces of the oven cavity and door.

Only warm soapy water must be used to clean surfaces.

Outer Surfaces

To clean the outside surface, use a damp cloth.

Avoid using abrasive products such as scouring pads that may damage the cosmetic surfaces. Make sure water does not seep into the ventilation slots.

Accessories should be washed in warm soapy water by hand.

CAUTION:

Some waveguide covers can be easily damaged, take care when cleaning.

Do not wash accessories in a dishwasher.

Cleaning surfaces that come into contact with food

For hygiene safety the glass tray should be cleaned regularly as it may come into contact with food.

It should be cleaned with warm soapy water and dried thoroughly.

If the inside of the oven cavity and door seal are not kept perfectly clean, there is a danger of damage due to sparking inside the oven cavity invalidating the warranty.

Never scrape the oven cavity walls with sharp objects.

SPECIFICATIONS

Rated input (Microwave): 1400W

Rated output (Microwave): 900W

Voltage: 230V~ 50Hz

Microwave frequency: 2450MHz

Dimensions (outer dimensions): (H) 290 x (W) 495 x (D) 409 mm

Dimensions (cavity / inner dimensions): (H) 251.5 x (W) 334 x (D) 347.6 mm

Weight (approx.): 12.96 kg



TROUBLESHOOTING

Normal Phenomena	
Microwave oven interfering TV reception	Radio and TV reception may be affected when the microwave oven is operating. It is similar to the interference of small electrical appliances, like mixer, vacuum cleaner and electric fan. It is normal.
Dim oven light	During low power microwave cooking, the oven light may become dim. It is normal.
Steam accumulating on door, hot air out of vents	During cooking, steam may come out of food. Most of steam will escape from the vents. But some of them may accumulate on positions like the oven door. It is normal.
Oven operation accidentally with no food in.	It is forbidden to operate the appliance without any food inside. Failure to do so can cause damage to the interior of the oven.

Problem	Possible Cause	Solution
Oven cannot be operated.	Power cord not plugged in tightly.	Unplug the appliance then plug it in again after 10 seconds.
	There is something wrong with the mains socket.	Test the mains socket by plugging another appliance in.
Oven does not heat up.	Door not closed well.	Close door well.
Glass turntable makes noise when microwave oven operates.	Dirty roller rest and oven bottom.	Refer to 'CLEANING AND MAINTENANCE' to clean dirty parts.
	Glass tray is not positioned properly.	Position the glass tray properly.